

## The Return-Stroke of Lightning Current, Source of Electromagnetic Fields (Study, Analysis and Modelling)

<sup>1</sup>Dib Djalel, <sup>2</sup>Haddouche Ali and <sup>1</sup>Chemam Fayçal

<sup>1</sup>Laboratory of Theory and Applied Physics LPAT, University Tebessa, Algeria

<sup>2</sup>Laboratory of Electro Mechanic Systems LSEM, F.S.I- Department of Electro Mechanics  
University of Annaba, Algeria

---

**Abstract:** In this study we present and analysis of the return-stroke lightning current and described their models which existing in the literature by several authors for the evaluation of radiated electromagnetic fields and modelling the coupling with electrical systems based on the calculation of induced voltages. the objective of this work is to take part in the improvement of the coordination of electric insulations and to put device also for calculation of the over-voltages induced in the electrical networks by the indirect lightning strokes which represent the most dangerous constraint and most frequent. A comparative study between the existing models and the analysis of the parameters which affect the space and temporal behaviour of the current lightning strokes as well as the importance of the lightning current at the channel base form the essential consequence of this study.

**Key words:** Lightning current, return stroke, models, electromagnetic field, coupling, channel base

---

### INTRODUCTION

The description of the spatial and temporal distribution of lightning current presents the most significant part for the evaluation of the electromagnetic fields radiated by the lightning and consequence calculation of the overvoltages induced in the electric systems. These lightning overvoltages are regarded as the most dangerous constraints for the electric systems because of their frequency and their randomness.

To have a satisfactory cartography of the electromagnetic field emitted by the lightning channel, it is necessary well to know to choose the current model in this channel that it is at the base or during its propagation.

In this study, we will describe some established approaches to model the current and the electromagnetic fields associated with the return stroke phase of a lightning discharge.

The evaluation of electromagnetic effects associated with a lightning return stroke process generally include the following points:

- \* Characterization and representation of the return stroke channel base current.
- \* Specification of the spatial-temporal distribution of the return-stroke current along the channel.
- \* Calculation of radiated electromagnetic fields.
- \* Modelling the coupling of electromagnetic fields to electrical systems.

### Electromagnetic field associated with a return

**stroke:** In general, the calculation of electric and magnetic fields associated with a cloud-to-ground lightning return stroke is based on a certain number of commonly-adopted assumptions, namely the lightning channel is represented by a straight vertical antenna along which the return stroke front propagates upward at the return stroke speed, the ground is assumed to be flat, homogeneous and characterized by its conductivity and its relative permittivity. Figure 1 shows a schematic representation of the lightning channel's assumed geometry and indicates also the observation point P where the fields will be calculated. The cylindrical coordinate system is adopted to represent the fields in this geometry. Wait<sup>[15]</sup> and Baños<sup>[11]</sup> treated the complete problem of the electromagnetic radiation of a dipole over a finitely conducting half-space by determining the solution of Maxwell's equations for both media in accordance with the boundary conditions on the air-ground interface. The resulting equations are obtained in the frequency domain and are in terms of slowly converging integrals (Sommerfeld integrals<sup>[3]</sup>).

The problem is greatly simplified if one assumes a perfectly-conducting ground. In that case, the components of the electric and magnetic fields at the location  $P(r,t,z)$  produced by a short vertical section of infinitesimal channel  $dz'$  at height  $z'$  carrying a time-varying current  $i(z',t)$  can be computed in the time domain using the following relation (1,2,3) by Uman<sup>[8]</sup>.

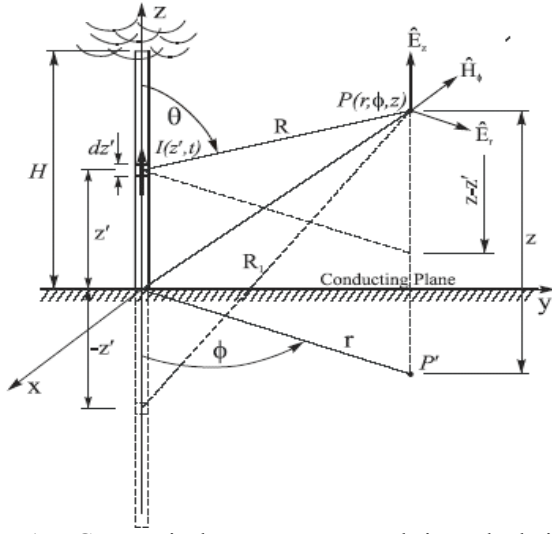

Fig. 1: Geometrical parameters used in calculating return stroke fields [Uman *et al*<sup>[8]</sup>]

$$E_z(r, z, t) = \frac{1}{4\pi\epsilon_0} \left[ \int_{-H}^H \frac{2(z-z')^2 - r^2}{R^5} \int_0^t i(z', \tau - R/c) d\tau dz' + \int_{-H}^H \frac{2(z-z')^2 - r^2}{cR^4} i(z', t - R/c) dz' - \int_{-H}^H \frac{r(z-z')}{c^2 R^3} \frac{\partial i(z', t - R/c)}{\partial t} dz' \right] \quad (1)$$

$$dE_r(r, \phi, z, t) = \frac{dz'}{4\pi\epsilon_0} \left[ \frac{3r(z-z')}{R^5} \int_0^t i(z', \tau - R/c) d\tau + \frac{3r(z-z')}{cR^4} i(z', t - R/c) - \frac{r(z-z')}{c^2 R^3} \frac{\partial i(z', t - R/c)}{\partial t} \right] \quad (2)$$

$$B_\phi(r, z, t) = \frac{\mu_0}{4\pi} \left[ \int_{-H}^H \frac{r}{R^3} i(z', t - R/c) dz' + \int_{-H}^H \frac{r}{cR^2} \frac{\partial i(z', t - R/c)}{\partial t} dz' \right] \quad (3)$$

After integration we obtained the fields equations:

$$R = \sqrt{(H-z)^2 + r^2} \quad \text{and} \quad H = v(t - \frac{R}{c})$$

$E_{r,z} = \frac{1}{4\pi\epsilon_0} I_0 (I_{1rz} + I_{2rz} + I_{3rz})$ : horizontal and vertical electric field

$H_\phi = \frac{1}{4\pi\epsilon_0} I_0 (I_{1H} + I_{2H})$ : Azimuthally magnetic field

where

- $i(z', t)$  is the current carried by the  $dz'$  at time  $t$ ;
- $\mu_0$  is the permeability of the vacuum;
- $\sigma_0$  is the permittivity of the vacuum;
- $c$  is the speed of light;

$R$  is the distance from the dipole to the observation point and  $r$  is the horizontal distance between the channel and the observation point.

In equations (1-2), the terms containing the integral of the current (charge transferred through  $dz'$ ) are called “electrostatic fields” and because of their  $1/r^3$  distance dependence, they are the dominant field component close to the source. The terms containing the derivative of the current are called “radiation fields” and due to their  $1/r$  distance dependence, they are the dominant component far from the source. The terms containing the current are called “induction fields”.

In Eq. (3), the first term is called “induction or magnetostatic field” and is the dominant field component near the source and the second term is called “radiation field” and is the dominant field component at far distances from the source. In these equations the presence of the perfectly conducting ground is taken into account by replacing the ground by an equivalent image.

The total fields produced by the return stroke current at the observation point are obtained by integration of the previous equations along the channel and its image.

In other work not in this study we developed a new analytic equations of electromagnetic field which related only with time.

The calculation of the electromagnetic field requires the knowledge of the spatial-temporal distribution of the current along the channel,  $i(z', t)$ .

**Return stroke current models:** Return-stroke current models have been the subject of some reviews in the last years, e.g. Gomes, Cooray, Nucci *et al*<sup>[4,5]</sup>; Rakov<sup>[6]</sup>; Thottappillil and *all*<sup>[8]</sup> Thottappillil and Uman<sup>[9]</sup> and Rakov<sup>[6]</sup> lightning return stroke models are categorized into four classes:

- a. The first defined class of models, gas dynamic or “physical” models, is primarily concerned with the radial evolution of a short segment of the lightning channel and its associated shock wave.
- b. Electromagnetic models, are usually based on the so-called lossy thinwire antenna approximation of the lightning channel. These models involve a numerical solution of Maxwell’s equations to find the current distribution along the channel from which remote electric and magnetic field can be computed
- c. The distributed circuit models, also called RLC transmission line models. They can be viewed as an approximation to the electromagnetic models and they represent the lightning discharge as a transient process on a transmission line characterized by resistance, inductance and capacitance, all per unit length. These models are used to determine the channel current versus time and height and can therefore also be used for the computation of remote electric and magnetic fields.

- d. The last class is the engineering models in which a spatial and temporal distribution of the channel current (or the channel line charge density) is specified based on such observed lightning return-stroke characteristics as current at the channel base, the speed of the upward propagating wavefront and the channel luminosity profile.

In this work, we will consider only the engineering models, essentially for two reasons. First, engineering models are characterized by a small number of adjustable parameters, usually only one or two besides the specified channel-base current. Second, engineering models allow the return stroke current at any point along the lightning channel,  $i(z',t)$ , to be simply related to a specified channel-base current  $i(0,t) = i_0(t)$ . Indeed, it is only the channel-base current that can be measured directly and for which experimental data are available.

**The Bruce-Golde (BG) model:** This model considers that the current  $i(z',t)$  equals the current at ground  $i_0(t)$  beneath the wave front of the upward-moving return stroke; above the wave front, similar to all the other return stroke models, the current is zero in (Fig. 2).

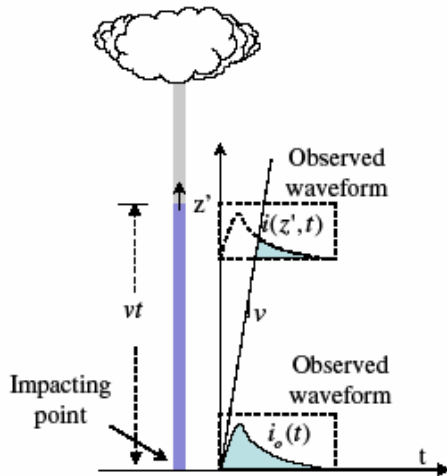

Fig. 2: Return stroke current propagating-upward by BG Mode<sup>[11]</sup>

$$i(z',t) = i(0,t) \quad \forall \quad z' \leq vt$$

$$i(z',t) = 0 \quad \forall \quad z' > vt$$

Where  $v$  is the propagation speed of the return stroke wave front. In this model a discontinuity appears at the return-stroke wave front, which represents an instantaneous removal of charge from the channel at each height  $z'=vt$  by the return-stroke wave front.

**The Transmission Line (TL) model (Uman and McLain):** This model assumes that the lightning channel can be represented by a lossless transmission line (Fig. 3) Therefore, the current waveform at the ground travels upward undistorted and unattenuated at a constant propagation speed  $v$ . Mathematically, the TL is described by

$$i(z',t) = i(0,t - z'/v) \quad \forall \quad z' \leq vt$$

$$i(z',t) = 0 \quad \forall \quad z' > vt$$

The TL model allows the transfer of charge from the bottom of the leader channel to the top and does not remove any net charge from the channel<sup>[4]</sup>.

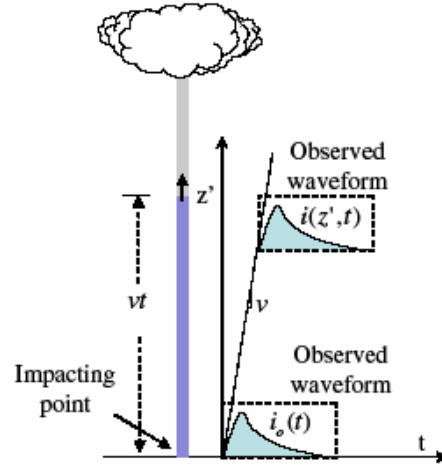

Fig. 3: Return stroke current propagating-upward according to the TL Model<sup>[11]</sup>

**The Modified Transmission Line (MTL) model:** Since the TL model does not allow charge to be removed from the leader channel and hence does not produce fields that are realistic at long times, two modifications to the TL model have been proposed by Nucci et al<sup>[2,3,4]</sup> and by Rakov and Dulzon<sup>[6]</sup>. These two models are described hereunder.

**MTLE model (Rachidi and Nucci):** In the modified transmission line model with exponential decay with height, MTLE<sup>[3,4]</sup>, proposed by Rachidi and Nucci, the current intensity is supposed to decay exponentially while propagating up the channel as expressed by,

$$i(z',t) = i(0,t - z'/v) \exp(-z'/\lambda) \quad \forall \quad z' \leq vt$$

$$i(z',t) = 0 \quad \forall \quad z' > vt$$

where the factor  $\lambda$  is the decay constant which allows the current to reduce its amplitude with height. This constant has been determined using experimental data to be about 2 km. The decay constant was introduced to take into account the effect of charges stored in the corona sheath of the leader which are subsequently neutralized during the return stroke phase.

**MTLL model (Rakov and Dulzon):** In the MTL model with linear current decay, MTLL<sup>[6]</sup>, the current intensity is supposed to decay linearly while propagating up the channel and it is expressed by,

$$i(z',t) = i(0,t - z'/v)(1 - z'/H_{sol}) \quad \forall \quad z' \leq vt$$

$$i(z',t) = 0 \quad \forall \quad z' > vt$$

where the factor  $H$  is the total channel height.

**The travelling current source (TCS) model (Heidler):** In the TCS model, proposed by Heidler, a current source travels upward at speed  $v$  from ground to the cloud. The current injected by this source at height  $z'$  is assumed to propagate down the channel at the speed of light  $c$ . Therefore, the current at height  $z'$  would be equal to the current at ground at an earlier time  $z'/c$ . This is mathematically described by,

$$i(z', t) = i(0, t + z'/v) \quad \forall \quad z' \leq vt$$

$$i(z', t) = 0 \quad \forall \quad z' > vt$$

**Generalization of the engineering models:** Recently Rakov<sup>[3]</sup> expressed the engineering models (including those described previously) by the following generalized current equation:

$$i(z', t) = u(t - z'/v^*)P(z')i(0, t - z'/v^*)$$

where  $u$  is the Heaviside function equal to unity for  $t \geq z'/v$  and zero otherwise,  $P(z')$  is the height dependent current attenuation factor and  $v^*$  is the current-wave propagation speed. Table 1 summarizes  $P(z')$  and  $v^*$  for the introduced five engineering models, in which,  $H_{tot}$  is the total channel height,  $\lambda$  is the current decay constant and  $c$  is the speed of light.

Table 1:  $P(z')$  and  $v$  in Eq. for five simple engineering models (Tabara<sup>[12]</sup>)

Model	$P(z')$	$v^*$
BG	1	$\infty$
TL	1	$v$
TCS	1	$-c$
MTLL	$1 - z'/H_{sol}$	$v$
MTLE	$\text{Exp}(-z'/\lambda)$	$v$

The Heaviside function  $u$  in the general expression introduces a mathematically more correct expression for the time dependence of the return stroke currents and will further improved estimations for fields.

**Channel base current:** An analytical expression usually adopted to represent the channel-base current  $i_0(t)$ , whose specific wave shape and amplitude can be determined experimentally, is the one proposed by Heidler and frequently referred to as the “Heidler function”:

$$i(0, t) = \frac{I_0}{\eta} \frac{(t/\tau_1)^n}{1 + (t/\tau_1)^n} \exp(-t/\tau_2)^n$$

$$\eta = \exp \left[ - \left( \frac{\tau_1}{\tau_2} \right) \left( n \frac{\tau_2}{\tau_1} \right)^{\frac{1}{n}} \right]$$

where,  
 $I_0$  is the magnitude of the channel-base current  
 $\tau_1, \tau_2$  are the front and the decay time constant  
 $n$  exponent having values between 2 to 10  
 $\eta$  is the amplitude correction factor.

In order to reproduce a specific return stroke waveform, very often a combination of two Heidler functions can be used.

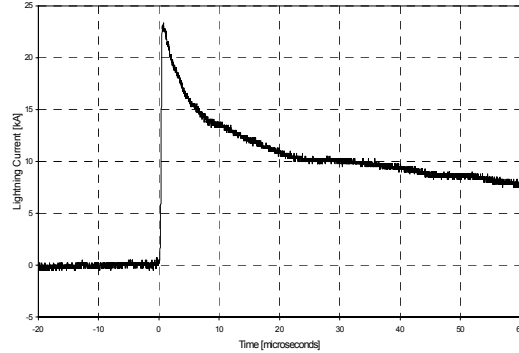

Fig. 4: Channel-base current wave shape experimental data<sup>[04]</sup>

The Heidler function has a time derivative equal to zero at  $t=0$ , consistent with measured return stroke current wave shapes and additionally, it allows precise and easy adjustment of the current amplitude, maximum current derivative and electrical charge transferred nearly independently by varying  $I_0, \tau_1$  and  $\tau_2$ , respectively.

Another model presented by the two exponential function is used by some authors:

$$i(0, t) = I_{01} \cdot (e^{-\alpha t} - e^{-\beta t}) + I_{02} \cdot (e^{-\gamma t} - e^{-\delta t})$$

Where  $I_{01}, I_{02}, \alpha, \beta, \gamma$  et  $\delta$  are the parameters which determined the two-exponential wave forme.

The comparison of the models are presented by this analytic result:

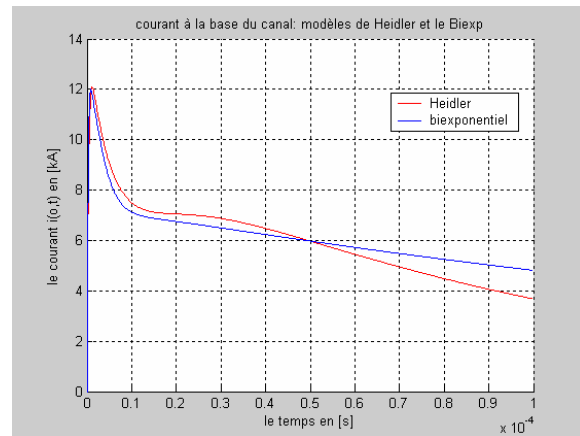

Fig. 5: Channel-base current wave shape Heidler and two exponential models

**Discussion and comparison between the return stroke models:** An adequate return-stroke current model should be a model that yields a good approximation to the observed current at the channel-base, to the observed electric and magnetic fields at various distances. Several authors<sup>[2,3,4,6,8]</sup> have studied the ability of the engineering models to predict the

electromagnetic field radiated by return strokes; recently Rakov in<sup>[6]</sup> mentions two primary approaches to evaluate that ability:

- \* The first approach involves using a typical channel-base current waveform and a typical return stroke propagation speed as model inputs and then comparing the model-predicted electromagnetic fields with typical observed fields.
- \* The second approach involves using the channel-base current waveform and the propagation speed measured for the same individual event and comparing computed fields with measured fields for that same specific event.
- \* The second approach is able to provide a more definitive answer regarding model validity, but it is feasible only in the case of triggered-lightning return strokes or natural lightning strikes to tall towers where channel-base current can be measured. In the field calculations, the channel is generally assumed to be straight and vertical with its origin at ground ( $z' = 0$ ), conditions which may be better approximations to subsequent strokes, but potentially not for first strokes. The channel length is usually not specified unless it is an inherent feature of the model, as is the case for the MTL model Rakov and Dulzon<sup>[6]</sup>. As a result, the model-predicted fields and associated model validation may not be meaningful after 25-75  $\mu$ s, the expected time it takes for the return-stroke front to traverse the distance from ground to the cloud charge source.

We based on the works realized by the following authors, we can extract a various results:

Nucci et al<sup>[9]</sup>, Rachidi, Rakov and Bermudez<sup>[4,6,11]</sup> identified four characteristic features in the fields at 1 to 200 km measured by Lin and used those features as a benchmark for their validation of the TL, MTLE, BG and TCS models. The characteristic features include:

- \* a sharp initial peak that varies approximately as the inverse distance beyond a kilometer or so in both electric and magnetic fields;
- \* a slow ramp following the initial peak and lasting in excess of 100  $\mu$ s for electric fields measured within a few tens of kilometers;
- \* a hump following the initial peak in magnetic fields within a few tens of kilometers, the maximum of which occurs between 10 and 40  $\mu$ s; and finally,
- \* a zero crossing within tens of microseconds of the initial peak in both electric and magnetic fields at 50 to 200 km. Nucci et al<sup>[2]</sup> conclude from their study that all the models evaluated by them using measured fields at distances ranging from 1 to 200 km predict reasonable fields for the first 5-10  $\mu$ s and all models, except the TL model, do so for the first 100  $\mu$ s.

The BG, MTL, TCS and DU models, but not the TL and MTLE models, are consistent with this characteristic feature.

Thottappillil and Uman<sup>[14]</sup> compared the TL, TCS, MTLE, DU and MDU models, using 18 sets of three simultaneously-measured features of triggered-lightning return strokes: channel-base current, return-stroke propagation speed and electric field at about 5 km from the channel base, the data previously used by J.C. Willett et al<sup>[15]</sup> for their analysis of the TL model. It was found that the TL, MTLE and DU models each predicted the measured initial electric field peaks within an error whose mean absolute value was about 20 percent, while the TCS model had a mean absolute error about 40 percent. The overall results of the testing of the validity of the engineering models can be summarized as follows:

- \* The relation between the initial field peak and the initial current peak is reasonably well predicted by the TL, MTL, MTLE and DU models.
- \* Electric fields at tens of meters from the channel after the first 10-15  $\mu$ s are reasonably reproduced by the MTL, BG, TCS and DU model, but not by the TL and MTLE models.

## CONCLUSION

It is concluded that although some models are thought to produce more accurate results and are more physically oriented despite their mathematical complexity, for most engineering coupling calculation any of the models are adequate in that all produce fields which are reasonable approximation to available measured fields from natural lightning and that are within a factor of 2 or so of each other. If one model has to be selected as the representing the most reasonable compromise between mathematical simplicity and accuracy in field reproduction, this is probably the MTL model, as supported also in work<sup>[12]</sup> which signalled the summary of statistics on the error of the model peak fields.

However, none of the models discussed takes into account the attachment process of the lightning discharge and hence, they probably do not accurately model the field at very early times.

Therefore, further experimental data are badly needed in particular, field data at very close range, presently missing, will allow a better test of these models in view of their application for induced voltage calculation.

Additionally, other features like the presence of an elevated strike object at ground level or the tortuosity of the channel, need further theoretical and experimental activity to be included in the models. Then in this field, one always seeks answers to questions to eliminate from uncertainties which disturb the scientific community of this contribute.



**Appendix:** To improve the originality of this work, we present the following experimental measurements which we have to carry out us even at the laboratories of high voltage of the LRE/EPFL in Switzerland (2005) on the electromagnetic field radiated by lightning impulse currents by a Marx generator (1100 Kv) travelling a conductor ( 7m of length and 6m of height ) as of the simulation of the currents at the lightning channel base and its space-temporal distribution along its propagation in the channel while basing on the MTL model.

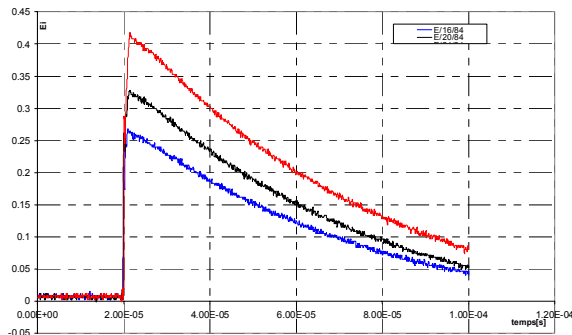

(Fig. 6a)

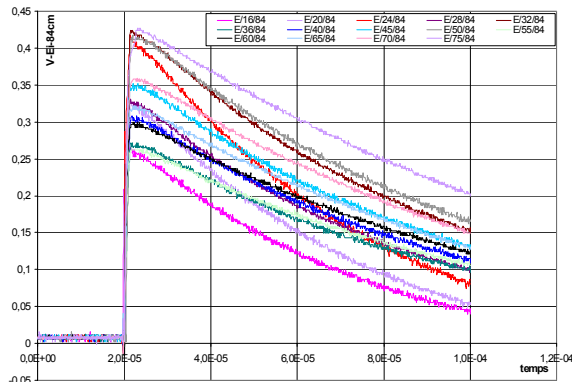

(Fig. 6b)

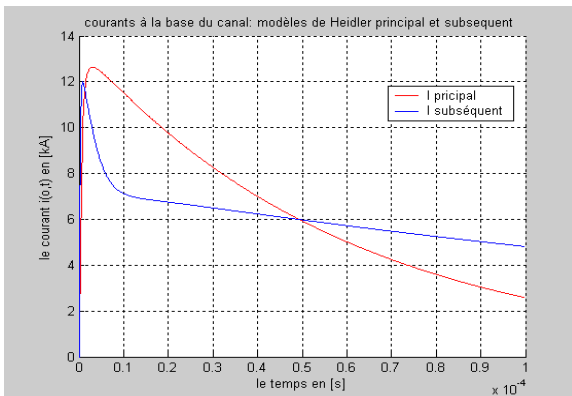

(Fig. 6c)

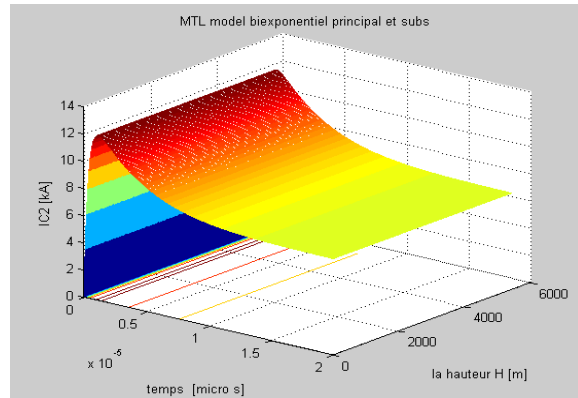

(Fig. 6d)

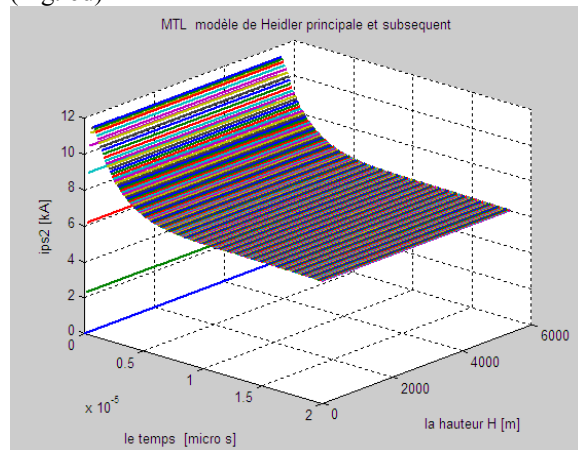

(Fig. 6e)

Fig. 6: Experimental curves LRE/EPFL 2005, a) vertical electric fields, b) horizontal electric field, c) Azimuthally magnetic fields, d) current base channel by Heidler model, e) current return stroke by MTL and Heidler model, f) current return stroke by MTL and two exponential model

### ACKNOWLEDGMENTS

We make a point of thanking Mr F. Rachidi and P.. Ezweiker for LRE/EPFL (Swiss) for their supports and their contributions during our stay of training course and Mr J. f. Affolter of the EIVD (Swiss) for its moral assistance and its encouragements to carry out our experiments of high voltage.

### REFERENCES

1. A. K. Agrawal, H. J. Price and S. H. Gurbaxani, 1980. Transient response of multiconductors transmission lines excited by a non-uniform electromagnetic field. IEEE. EMC2, 2(2): 119-29.
2. C. Nucci, G. Diendorfer, M. Uman, F. Rachidi, M. Ianoz and C. Mazzetti, 1990. Lightning return stroke current models with specified channel-base current: A review and comparison. Intl. J. Geophys., Res, (95): 395-408.

3. C. A. Nucci, 2000. Tutorial on Lightning-induced effects on transmission lines. 4th Intl Symp. on Electromagnetic Compatibility EMC. Zurich: 69-75
4. C. A. Nucci. and F. Rachidi, 1989. Experimental validation of a modification to the transmission line model for LEMP calculations. 8<sup>th</sup>. Intl. Symp. on Electromagnetic Compatibility EMC, Zurich: 6-11.
5. F. Rachidi and C. A. Nucci, 1990. On the master, Uman, Lin, Standler and the modified transmission line lightning return stroke current models. Intl. J. Geophys. Res, 95: 20389-94.
6. V. A. Rakov, A. A. Dulzon. 1987. Calculated electromagnetic fields of lightning return strokes. Russia. *Tekhnicheskaya Electrodinamika*,(1): 87-89.
7. M. Rubinstein, 1996. An approximate formula for the calculation of the horizontal electric field from lightning at close, intermediate and long range. IEEE Trans. EMC. 38: 531-5.
8. G. Diendorfer, M. A. Uman, 1990. An improved return stroke model with specified channel base current. Intl. J. Geophys. Res. 95. D(9):13621-13644.
9. C. A. Nucci, 1995. Lightning Induced voltages on overhead Power lines. PI, *Electra*. (161): 26-39.
10. C. A. Nucci, 1995. Lightning induced voltages on overhead power lines. PII, *Electra*, (162): 63-79.
11. J. L. Bermudez, 2003. Lightning currents and electromagnetic fields associated with return strokes to elevated strike objects. Ph. D. Thesis No. 2741. EPFL : 65-98.
12. D. Tabara, 1999. Effets Electromagnetic effect of lightning and switching in the transformation center under metallic envelops. PhD Thesis N°1970, EPFL : 17-38.
13. F. Heidler, 1985. Travelling current source model for LEMP calculation. Proc. 5<sup>th</sup> Intl. Symp on Electromagnetic Compatibility EMC , Zurich: 5-7.
14. R. Thottappillil, M. A. Uman, 1993. Comparison of lightning return stroke models. J. Intl Geophys. Res. ( 93,98, 22): 903-914.
15. J. C. Willet and all, 1988. An approximate test of the transmission line of electromagnetic radiation from triggered lightning return-stroke. Intl. J. Geophys. Res., (93): 3867-3878.