

Original Research Paper

# A Multi-Criteria Optimization Approach to Cam Curve Design Combining Different Splines Given by Fixed and Adjustable Checkpoints

<sup>1</sup>Léo Moussafir and <sup>2</sup>Vigen Arakelian

<sup>1</sup>MECAPROCE, INSA Rennes, 20 av. des Buttes de Coesmes, CS 70839, F-35708 Rennes, France

<sup>2</sup>LS2N-ECN UMR 6004, 1 Rue de la Noë, BP 92101, F-44321 Nantes, France

## Article history

Received: 31-01-2023

Revised: 31-01-2023

Accepted: 15-02-2023

## Corresponding Author:

Vigen Arakelian

LS2N-ECN UMR 6004, 1 Rue

de la Noë, BP 92101, F-44321

Nantes, France

Email: vigen.arakelian@insa-rennes.fr

**Abstract:** This study proposes a multi-criteria design optimization of cam mechanisms. This approach is based on the multistage interconnection of different tools: MATLAB, ADAMS, and mode frontier. It consists of three main issues: (i) The polynomial representation of splines given by checkpoints defining the specific motion of the follower; (ii) The connection of these splines by different degrees of fitting in order to combine them in the entire cam profile and (iii) The optimization including the adjustable checkpoints according to the objectives and the constraints formulated for a different area of the cam profile. An illustrative example based on the optimization of a production machine cam profile is discussed. The suggested methods of multi-criteria design optimization are validated by experimental tests. The given results show the effectiveness of the proposed approach and the possibility of their application in the real world of manufacturing.

**Keywords:** Cam Design, Multi-Criteria Optimization, Interpolation, Cam Motion Synthesis, Jerk, Contact Stress

## Introduction

Optimization is a mathematical practice to find the best solution to a problem. This method has many applications: Mechanics, physics, finance, sociology, computer science, etc. The challenge is the same for each field: To be able to convert the problem encountered into a mathematical problem. The objective guides the search for a solution, for example, wanting to lighten an aircraft wing results in the minimization of its mass. The elements on which we can play become variables, in the example, the mass is defined by the type of material used as well as by the volume of material. Finally, the obstacles to the problem are transcribed into constraints, still, in the example, a specific external shape, as well as a minimum rigidity, must be guaranteed. The search for the best solution is done by playing on the combinations of variables.

Through the methods developed, a solution is found to satisfy all of these elements. If the mathematical principle may seem simple to achieve for a restricted problem, things get complicated when the problem involves

antagonistic objectives, discrete variables, and complex equations. The numerical resolution then becomes an obligation and the transcription of the real problem into an algorithm becomes a field of study in its own right. To solve the problem thus transcribed, many methods have emerged. One of the best-known and oldest is the simplex method proposed by Dennis Jr *et al.* (1985), which makes it possible to quickly find a solution to a single objective problem. This extremely efficient algorithm only works under very specific conditions and the calculation time can become too long in certain cases. These methods are often inspired by nature: Genetic algorithms use the theory of evolution with the conservation of characteristics allowing survival from generation to generation as well as the introduction of spontaneous mutations. Among these, the MOGA-II is one of the most famously used.

A cam can be defined as a mechanical element having a curved profile, which gives a predetermined specified motion to the follower. Cam follower mechanisms, required to operate at a constant speed to specify the variety of output motion, are widely used in the mechanical industry due to their precise movement and simplicity of design (Chen, 1982; JCMA, 2001;

Tsay and Lin, 1996). By the application of cam mechanisms in production machines, an unlimited variety of motion can be obtained. Cams can provide unusual and irregular motions that may be impossible or very complicated to be carried out with the other types of mechanisms. The selection of a mathematic function for a displacement law is one of the important tasks since the selected function affects the shapes of curves and peak values of the velocity, acceleration, and jerk-on motion curves.

A number of conventional curves have been suggested to express the cycloidal, the modified sin curve, the modified trapezoidal curve, and the B-splines (Tsay and Lin, 1996; Wu *et al.*, 2009; Sateesh *et al.*, 2009; Xiao and Zu, 2009; Reeve, 1995; Nga *et al.*, 2021; Qiu *et al.*, 2005). In these studies, B-spline has been used to define the displacement function, which is satisfied by discrete constraints on follower displacements, velocities, and accelerations. The high-order B-spline function has been also applied to cam design (Mandal and Naskar, 2009; Naskar and Mishra, 2012). In the study of Nguyen *et al.* (2019), a general framework for the motion design of cam mechanisms using a Non-Uniform Rational B-Spline has been discussed. To establish motion curves, the system of linear equations has been set up by arbitrary boundary conditions of the follower motion on displacements, velocities, accelerations, and jerks and the reduction of peak values of the acceleration and jerk has been achieved. The Bezier technique has also been used for synthesizing the displacement function (Ting *et al.*, 1994; Cardona *et al.*, 2013). The optimal design of the cam mechanism was widely discussed in various publications (Chen, 1982; Norton, 2002; Bouzakis *et al.*, 1997; Mitsi *et al.*, 2001; Tsiafis *et al.*, 2009; Mansour *et al.*, 2013; Qiu *et al.*, 2005), where several constraints and approaches were considered. There are various criteria for the improvement of cam design, such as increasing their superficial hardness and reducing friction coefficient (Bouzakis *et al.*, 2007; Bobzin *et al.*, 2012), avoiding cam wear and follower jump (Flocker, 2009) minimization of the follower acceleration jerk and contact stress (Acharyya and Naskar, 2008) and improving the dynamic behavior of cam mechanisms by reducing follower undesired vibrations (Cardona *et al.*, 2002; Andresen and Singhose, 2004; Flocker, 2007). A lot of optimization methods and algorithms have been also adopted by researchers to improve the cam design. They proposed the golden section method (Hwang and Yu, 2005), the Lagrange multipliers method (Kaplan, 2014), and the Kriging method (Qin and He, 2010), by using Genetic Algorithm (Tsiafis *et al.*, 2009; Xiao and Zu, 2009; Cabrera *et al.*, 2002). Fourier's series (Cabrera *et al.*, 2002), by coupling the analytical law with numerical expressions (Ottaviano *et al.*, 2008), and polynomial

approach (Tsay *et al.*, 1996; Acharyya and Naskar, 2008). A closed-form optimization was proposed for a trapezoidal splined acceleration profile by Flocker and Bravo (2013). Further works proposed the improvement of dynamical behavior by adopting a variable speed cam (Yan *et al.*, 1996a-b). In order to optimize the dynamic behavior of mechanisms and to establish a flexible model of the machine, a method based on a lumped model to predict vibrations and natural frequencies is a promising approach (Hu *et al.*, 2021; Guo *et al.*, 2015). These methods take into account the gyroscopic effect of the rotary shaft and rotor in high-speed engines and allow one to predict the dynamic response of the follower in regard to all the flexibility in the kinematic chain.

A new method for cam profile design and optimization by integrating a single objective optimization procedure with a dynamic model of cam follower mechanism in the delivery system of an offset press was proposed in the study of (Ouyang *et al.*, 2017). The aim of the recent paper of (Borboni *et al.*, 2020) is to study and quantify the profile interpolation process and suggest a correct choice of the number of points that describes the profile. In the paper of Mermelstein and Acar (2004), a method based on a piecewise polynomial is proposed. It requires imposing the same degree of control on all the breakpoints and the same continuity condition for all. For illustration, the case of a single dwell rotary that came with translating a follower was presented via numerical and experimental tests.

A similar method but with more flexibility to impose, for example, using the second derivative of a checkpoint or a continuity  $C^3$  between two polynomials and  $C^2$  between two others will be discussed below. Our observations have also shown that usually the cam profile is designed in such a way that the various criteria given in the above-mentioned studies apply to the entire curve. However, in many cases, the criteria may be conflicting for different cam profile zones. In other words, it is necessary not only to optimize different splines with given control points, to combine them, but also to find agreement with these criteria.

This study proposes a new solution for the design of a cam profile combining different splines given by fixed and adjustable checkpoints. In the suggested design, there are two types of checkpoints. The fixed checkpoints are given by the geometric parameters and the boundary conditions. For some fixed checkpoints, the boundary conditions can be presented as variables, which can be used during the optimization. The adjustable checkpoints have only free variables, which are determined during the optimization. Thus, the added adjustable checkpoints allow one to create more flexibility during the optimization and to obtain results, which are better than in the case of the optimization with only fixed checkpoints. The initial curve used for illustration has been optimized several times by

traditional optimization methods and has reached its limit. The proposed approach to cam curve design gives better results that were validated by experimental tests.

### Problem Formulation

The design of the cam of high-speed production machines, which have different operating criteria, has certain requirements not only for the entire curve of the cam profile but also for specific zones. For example, it is necessary to lift, stop and return the follower, to respect the positions of the follower at the control points. At the same time, to ensure the continuity of the acceleration at all the control points, to maintain the permanent contact between the cam and the follower roller, to ensure minimum contact force in certain areas, to reduce the maximum Hertz pressure, to assume the continuity of the acceleration jerk, the minimum pressure angle, the minimum return time, etc.

Figure 1 and 2 allow the comprehension of the mechanism. The studied mechanism is composed of a main console, a support, and a follower. The follower rolls on the cam (it is not shown), is open and cylindrical.

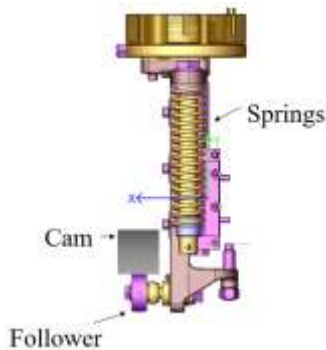

**Fig. 1:** Cam mechanism with spring assuming the contact between the cam and the roller follower ensuring vertical displacements

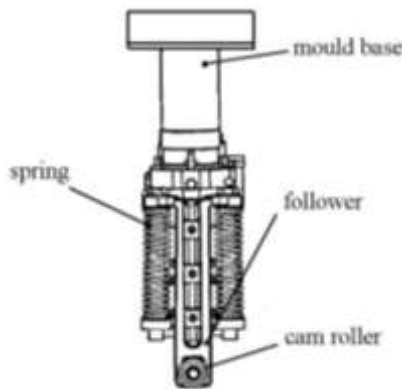

**Fig. 2:** A simplified design of the mechanism in order to understand its operation

There are 4 characteristic points:

- The center of the follower moving according to the motion law
- The center of the prismatic link
- The center of the mass of the support
- The application point of the resultant spring's forces

The main effort applied to the support are:

- Inertial force due to the acceleration
- Spring elastic force
- Cam roller force
- Force in the prismatic joint

It is conspicuous that we can observe these conflicting objectives. For example, the forces and torques in a cam mechanism are directly generated by the motion profile and the contact forces between the follower and the cam can be expressed as:

$$F = \left[ m\dot{\theta}^2 f''(\theta) + N_{spring} k (L_0 - L) \right] + mg / \sin(\alpha) \quad (1)$$

where,  $\theta$  is the angular position of the cam,  $F$  is the force between the cam and the follower,  $f''(\theta)$  is the second derivative of the cam profile with respect to  $\theta$ ,  $N_{spring}$  is the number of springs,  $k$  is the stiffness coefficient of the spring,  $L_0$  is the initial length of the spring,  $L$  is the length of the spring at current position;  $m$  is the total mass of the follower,  $g$  is the gravitational acceleration and  $\alpha$  is the pressure angle.

The pressure angle can be determined from the following equation:

$$\alpha = \alpha(f'(\theta)) \quad (2)$$

where,  $f'(\theta)$  is the derivative of the cam profile with respect to  $\theta$ .

The minimal time of the return of the follower can be expressed as:

$$t_{reum} = \frac{\theta_{end} - \theta_{start}}{\dot{\theta}} \quad (3)$$

where,  $\theta_{end}$  is the angle at which the follower is in the up position,  $\theta_{start}$  is the angle at which the follower is in the down position, and  $\dot{\theta}$  is the angular velocity of the cam.

As we can see from this simple illustrative example, in these equations there are conflicting objectives.

For a constant angular velocity  $\dot{\theta} = const$  and the same  $\theta_{start}$ , in order to decrease  $t_{reum}$ , we have to decrease  $\theta_{end}$ , so  $f'(\theta)$  will increase consequently the value of the contact force  $F$  between the cam and the follower will also increase.

But on the entire motion profile, it is possible to have various goals. With classical methods, it is hard to find an optimized compromise for each goal of the entire cam

profile. It will be better to divide the entire profile into different sections. Then, define objectives for each section and carry out the required minimization. Subsequently, the sections will be combined according to their boundary conditions and the  $f(\theta)$  will improve by using optimization algorithms. These considerations are the result of repeated discussions with engineers from different companies faced with real industrial problems.

### Multi-Criteria Design Optimization Strategy

#### Overview of the Strategy

In order to optimize a motion law already industrially functional, new solutions must be found. To have good flexibility on the curve geometry, a polynomial function is a good choice according to the state of the art. However, the main drawback is the link between each polynomial spline. With flexibility on the join class, others solutions must be reached for the considered problem, which is a very constraint problem. In addition, introducing more flexibility leads to more variables. To find a set of variables that suit our problems robustly and swiftly for industrial purposes is not simple. A combination of this very flexible method and an optimization approach using the proper algorithm is envisaged.

#### The Polynomial Representation of Functions to be Optimized

When designing cam mechanisms, an often-imposed law of motion is created so that the roller passes through control points that provide a certain movement of the system. In addition, the motion profile should not create significant constraints during the operation of the mechanism. Thus, the motion profile must be chosen according to certain goals such as the limitation of contact forces, the continuity in Jerk, etc.

All of these limitations can be expressed mathematically, but traditional cam design methods do not allow much flexibility in the choice of the form of the law of motion. Therefore, the cam synthesis is tedious and not robust to meet all the criteria successfully.

In order to better control changes in the law of motion, the polynomial sectional approach allows for greater flexibility and accuracy because it performs control point interpolation rather than just a point fit. The polynomials are easily differentiable, which makes it possible to interpolate not only position curves but also successive derivatives.

The displacements imparted by a cam profile can be described using a polynomial function:

$$p(x) = a_n x^n + a_{n-1} x^{n-1} + \dots + a_2 x^2 + a_1 x + a_0 \quad (4)$$

with:

$$p(x_i) = y_i$$

Basically, it leads to a system of the linear equation:

$$\begin{pmatrix} x_0^n & x_0^{n-1} & x_0^{n-2} & \dots & x_0 & 1 \\ x_1^n & x_1^{n-1} & x_1^{n-2} & & x_1 & 1 \\ \vdots & \vdots & \vdots & \ddots & \vdots & \vdots \\ x_n^n & x_n^{n-1} & x_n^{n-2} & \dots & x_n & 1 \end{pmatrix} \begin{pmatrix} a_n \\ a_{n-1} \\ \vdots \\ a_0 \end{pmatrix} = \begin{pmatrix} y_0 \\ y_1 \\ \vdots \\ y_n \end{pmatrix} \quad (5)$$

To interpolate as well the derivatives, other systems must be solved:

$$p'(x) = na_n x^{n-1} + (n-1)a_{n-1} x^{n-2} + \dots + 2a_2 x + a_1 = \frac{\partial y_n}{\partial x} = y'_i \quad (6)$$

and:

$$p''(x) = n(n-1)a_n x^{n-2} + (n-1)(n-2)a_{n-1} x^{n-3} + \dots + 2a_2 = \frac{\partial^2 y_n}{\partial x^2} = y''_i \quad (7)$$

Depending on the given constraints, the derivatives of the polynomial function can reach the maximum order  $m$ :

$$\begin{pmatrix} x_0^n & x_0^{n-1} & x_0^{n-2} & \dots & x_0 & 1 \\ n x_0^{n-1} & (n-1)x_0^{n-2} & (n-2)x_0^{n-3} & \dots & 1 & 0 \\ (n-1)n x_0^{n-2} & (n-2)(n-1)x_0^{n-3} & (n-3)(n-2)x_0^{n-4} & \dots & 0 & 0 \\ \dots & \dots & \dots & \ddots & \dots & \dots \\ x_n^n & x_n^{n-1} & x_n^{n-2} & \dots & 0 & 0 \end{pmatrix} \begin{pmatrix} a_n \\ a_{n-1} \\ a_{n-2} \\ \vdots \\ a_0 \end{pmatrix} = \begin{pmatrix} y_0 \\ y'_1 \\ y''_0 \\ \vdots \\ \frac{\partial^m y_n}{\partial x^m} \end{pmatrix} \quad (8)$$

With this matrix, it is very easy to impose a condition on  $y$  or its derivatives.

The system of Eq. (8) is modular which means several lines can be deleted depending on the degree of management imposed on each control point.

The vector obtained in Eq. (8) comprises the set of boundary conditions  $y_i$  of the problem for points  $x_i$ . Therefore, the unknowns are the factors  $a_i$ , which are the polynomial coefficients. Thus, the resolution of this system gives directly to the polynomial coefficients, which satisfy all the boundary conditions.

#### Algorithm to Combine the Obtained Splines

This method has a drawback because of the Runge phenomenon: The interpolation can be achieved only with a pair of points. So, to create an entire law, it is necessary

to join the different sections of splines. The fitting between each section of the polynomial function must be well chosen to not create an inadmissible constraint in the mechanism. Basically, one of the main requirements is to ensure a continuous acceleration in order to control dynamic parameters in each point of the motion law.

In accordance with the objectives and the location of the fitting, the connections between the polynomial sections are selected.

Due to the physics, there is a minimal functional class of connection, but these parameters are adjustment variables and this allows more flexibility in the research of solution. The degree of the polynomial is not the main criterion to optimize. A checkpoint can have some boundary conditions for a spline and another boundary for the next spline.

In this way, the entire motion law is created at the end of the process as well as all the data about the constraint. The main drawback of this method is the difficulty to find a suitable combination of parameters in terms of position  $y$ , derivative  $\partial y_n / \partial x$ , second derivative  $\partial^2 y_n / \partial x^2$ , and variable  $x$  in (8). The best combination depends on the constraints and goals associated with kinematic and dynamic models of the cam mechanism.

Figure 3 shows the suggested algorithm for optimization. With the suggested algorithm, the motion law is generated in a procedural way via polynomial sections and then they are connected to each other taking into account a continuity as mentioned before, i.e., creating the set of the function  $f(\theta)$ . It provides information relating to the mechanism to be optimized, such as efforts, torques, real-time displacements, etc.

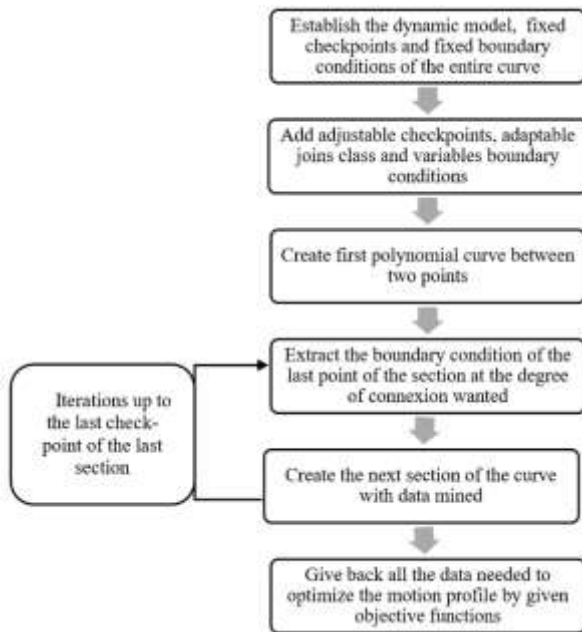

**Fig. 3:** Scheme of the algorithm of law created by assembling polynomial curves

### Multi-Criteria Optimization of the Cam Profile

The given algorithm allows one to generate sections of polynomials under constraints and to connect them with a defined degree of the fitting. However, it is difficult to find the right parameters of the law to obtain a law of movement that respects all the constraints and gives the best results on the set objectives. Therefore, the boundary conditions of each section of polynomials are considered variables, and certain limiting conditions are also imposed. For example, the starting position, the checkpoints, or a zero speed at the arrival of certain zones. With the polynomial sections, it is easy to add boundary conditions in order to have more flexibility in controlling the obtained curve. For example, by adding a boundary condition up to Jerk, other solutions can be found because the addition of this variable will give new solutions that always respect the imposed limit conditions.

With the same reasoning, adding adjustable checkpoints expands possible curve geometry solutions. These adjustable checkpoints contain variable boundary conditions and with a proper optimization algorithm, we can determine the best location for them and their best boundary conditions. The method is not only based on a polynomial function to create a cam curve but also on the research of other points that improved the result.

However, the addition of boundary conditions and the extra points bring further difficulties in finding the exact combination of all variables. Therefore, the suggested approach uses optimization algorithms to find the best combination of variables no matter the number.

To solve the problem of multi-objective optimization, two solutions can be applied. Firstly, consider the objectives individually and use a Pareto border to make a choice among the panel of all the solutions. This method is efficient with genetic algorithms but overall poor with the algorithms based on the gradient method. The second solution is to set up only one objective function in order to gather the objectives into one. Each objective is weighted by a chosen coefficient then the numerical values of the objectives are positive if the goal is to maximize it and negative if the goal is to minimize it. Such an objective function is the sum of all goal values. Thus, the problem can be considered a mono-objective problem with the use of algorithms based on the gradient method.

Let us consider an illustrative example based on an industrial cam profile to better understand the proposed optimization approach.

### Illustrative Example with Simulations Carried out on the Base of an Industrial Cam Profile

#### Industrial Cam Profile to be Optimized

In order to show the efficiency of the suggested method, in this section, an optimization of a production machine's cam profile is considered the profile is shown in Fig. 4.

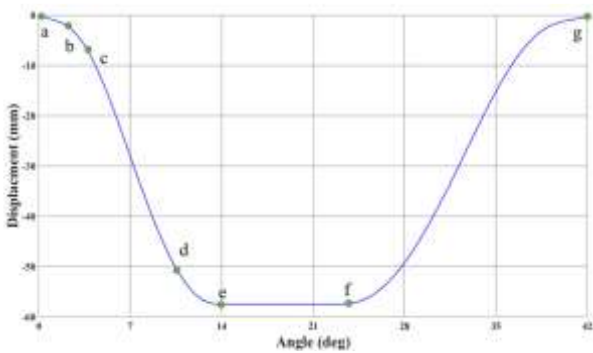

**Fig. 4:** The current motion law of the cam mechanism to be optimized

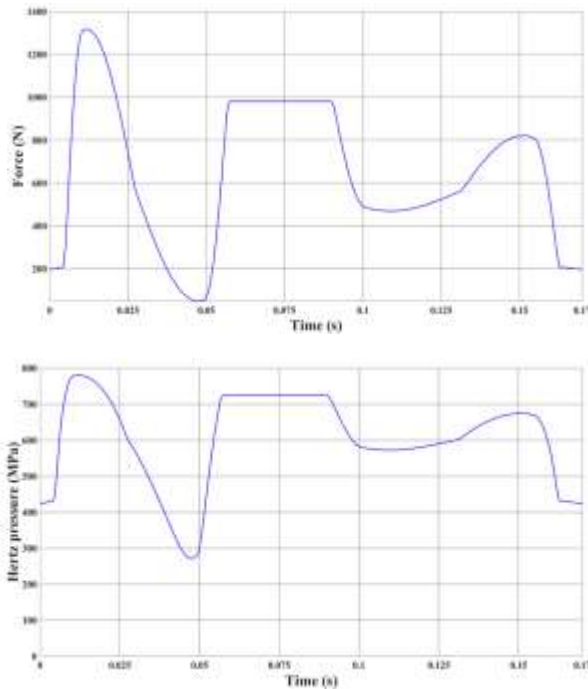

**Fig. 5:** Contact force and Hertz pressure generated by the current motion law

The examined cam system is similar to the mechanism given in Fig. 1. The roller follower carried out rise, dwell, and return motions. To ensure the exact operation of the cam mechanism, the roller follower must go through precise checkpoints shown in Fig. 4. point "a" is the beginning of the movement. Point "b" is the end of a linear part that ensures a good fit between the cam and the follower when it arrives; this part is useful to make up the variable gap between each unit. Point "c" guarantees that the links of mechanisms will not collide during their various movements. Point "d" is the point to reach as fast as possible, so all the process can pursue, the point "e"

and "f" ensure maintain the mechanism at a certain value during the process, i.e., ensure to remain for a while (or "dwell") at altitude and finally, the point "g" is here to replace the mechanism in its original position. The checkpoints are determined from the condition of the exact reproduction of the follower's motion. It should be noted that the given profile was developed using traditional optimization methods and further improvement is a challenge. The contact force and Hertz pressure between the cam and the roller are shown in Fig. 5. The suggested approach is considered a new stage to optimize the given cam mechanism. Hence, in the next sub-section, the optimization objectives will be described.

### Objectives and Constraints of the Optimization

Three objectives have been defined depending on the technological constraints and the zones where they are located.

*The minimization of the maximum Hertz pressure.* At present, the maximum Hertz pressure determines the maximum input speed. The subsequent increase in the input speed is not possible due to the rapid wear of the cam profile. This means that by minimizing the maximum Hertz pressure, it is possible to increase the input speed and, as a consequence, increase the productivity of the machine. If the input speed remains the same, while minimizing maximum Hertz pressure, the durability of the cam will increase.

*The minimum contact force between the cam and the roller.* This problem is complex enough. On the one hand, it is necessary to ensure reliable contact between the roller and the cam, i.e., ensure minimal contact force between the roller and the cam. The observations showed that it is desirable to slightly increase the minimum value of the contact force. However, it is not desirable to increase the maximum value of the contact force. On the contrary, it is desirable to reduce it.

*The jerk minimization.* The observation is shown that in the zone of the curve for  $t \in [0.09; 0.17 \text{ s}]$ , where, the constraints are rather weak, the jerk must be minimized in order to reduce the vibrations.

There are four constraints defined by the reliable operation of the cam mechanism:

- The maximum displacement  $|y| < 58 \text{ mm}$ , due to the operating length of the spring
- $F > 50 \text{ N}$  on the entire profile to ensure permanent contact between the came and the roller follower. This value is determined by experimental tests and was proposed by our industrial partner. Thus, it cannot be less than 50 N. However, it is desirable that the minimum contact force be greater in order to provide more reliable contact between the rollers and the cam
- Hertz pressure must be less than 900 MPa on the entire profile due to the mechanic limit of the materials in contact



- The radius of curvature of the cam must be, at each point, superior to the radius of the roller

### Parametrization of the Splines

Let us start by placing the checkpoints of the cam profile and the description of boundary conditions. There are seven checkpoints that ensure the specific motion of the cam mechanism (Fig. 4).

In order to better control the curve between the zones with the first and the second objectives, let us add a free point “c” between the point’s “c” and “d” because these two points are distant, consequently, we have more freedom on the curve in this section. This is not necessary for the other points due to their proximity; the influence of boundary conditions is enough to control the curve. We will add the boundary conditions on the checkpoints and on the free point “c”. These boundaries included the successive derivative of the displacement. Thus, the set of variables for the optimization problem is:

$$x_b; x_c; x_e; x_f; y_c; y_e; y'_c; y'_e; y'_d; y'_e; y''_c; y''_e; y''_d; y''_e$$

We can now develop all splines of a polynomial given by checkpoints. Then, the connection conditions for each checkpoint will be added.

The continuity of Jerk gives smooth accelerations on all segments of the curve. It can reduce the vibration of the cam mechanisms and their impact velocity. It can affect positively the stability of the cam mechanism and reduce the wear rate. So, a class  $C^4$  is better when the Hertz pressure is high.

With all these conditions on boundaries and connections, the polynomials are now created and linked. The next step is to find the best combination of variables based on the mentioned objectives. For this purpose, the optimization algorithm is used.

### Parameters for the Optimization Algorithm

The problem is defined by the following parameters. Design variables:

$$X = [x_b; x_c; x_e; x_f; y_c; y_e; y'_c; y'_e; y'_d; y'_e; y''_c; y''_e; y''_d; y''_e]$$

Parameter of the MOGA II: Number of generations: 300, DOE: 20; Number of objectives: 3; Number of constraints: 4. The DOE (design of experiments) is created with a Sobol method to cover the dominium.

The function to minimize is:

$$f(X) = w_1 F_{\max} + w_2 F_{\min} + w_3 J \quad (9)$$

where,  $F_{\max}$  is the maximal value of Eq. (1),  $F_{\min}$  the minimal value of Eq. (1),  $J$  the maximal value of the Jerk for  $t \in [0.09; 0.17 \text{ s}]$  and  $w_1$ ,  $w_2$  and  $w_3$  are the weighing factors. These values are flexible due to the antagonist's objectives: Minimize  $F_{\max}$  and maximize  $F_{\min}$ . This equation is the representation of the multi-objective approach. The final choice would be picked up [in the Pareto front of the solutions which is composed of plenty of different. To illustrate the choice, the weighing factors are  $w_1 = 6$ ,  $w_2 = 2$ , and  $w_3 = 1$ . The choice is made with regard to objectives but also to the robustness of the solution. To ensure performance despite the variation of the manufacturing process.

The optimization is performed on mode frontier software. The dimming range of the design variables is continued and extended. For the position variable, the value is between 0 and 58 mm which is the maximal value for the displacement in order to avoid contact with the coil in the spring. The first derivatives are between 200 and 200  $\text{m.rad}^{-1}$  and the second derivatives are between 1000 and 1000  $\text{m.rad}^{-2}$ . This magnitude is about 5 times the present law.

### Simulation Results

Figure 6 shows Hertz pressure. The reduction is 10 Mpa, which may seem negligible but this cam has been optimized through the past years and even a few MPa less can make a difference in the performance. That allows one to increase the input angular velocity of the cam and consequently, the machine's productivity.

In Figs. 6 and 7, we can observe that the minimal contact force is increased up to 60%, which allows one to ensure permanent and reliable contact between the cam and the roller follower. The optimization also leads to the continuity of the Jerk, which is a constraint in the parameter used for the optimization. The continuity in Jerk can make a good difference in terms of stability and vibration reduction when there is a high level of pressure.

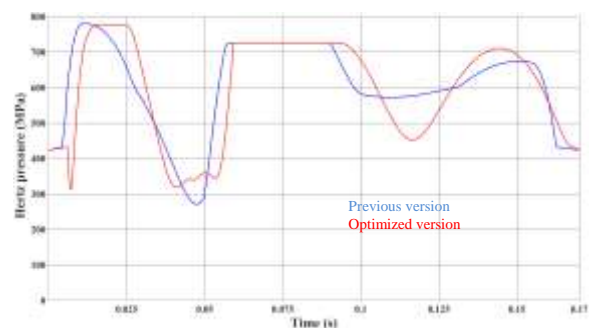

**Fig. 6:** Hertz pressure generated by the previous and optimized motion laws

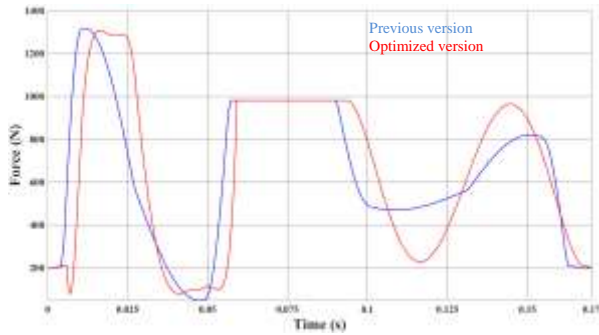

**Fig. 7:** Force generated by the previous and optimized motion laws

So, the optimization gives a  $C^4$  class when the Hertz pressure is high to avoid much jerk. In Fig. 8, it can be seen that the maximal value of the jerk is reduced for  $t \in [0.09; 0.17 \text{ s}]$  according to the optimization's objective.

This analysis is very good and hopeful but deals with only the theoretical model. In order to improve this model and reduce the gap between prediction and reality, some work on the dynamic of the mechanisms has been undertaken.

#### ADAMS Simulations

The function of the mechanism is key to the global process and the objectives established in the MATLAB simulation are consistent but in regard to the other machines in the process, the lifetime is even more important to avoid breakdown. The shaft that supports the roller is a fused design to break first in the worst case. This shaft is designed with respect to mechanical fatigue and more specifically the Dang Van method (Jabbado, 2006). Some study has been carried out to find out the correlation between the maximal effort suffered by the shaft during the cycle and its lifetime. Fatigue laws are obtained and this SN law can predict the lifetime.

As we can see in Fig. 9, the evolution is plotted with a logarithmic scale. Even a short improvement, in theory, leads to great benefits in the simulation. The simulations given in Fig. 6 have been carried out via MATLAB with perfect joints, i.e., without clearances, shock effects in contacts, vibrations, etc. To have a better overview of the improvement of the optimization, a simulation under ADAMS is performed with a nonlinear contact between the cam and the follower (Fig. 10). In this simulation, we can directly see the effect of vibrations and shock. The maximum effort is approximately 500N (15%) less than the actual solution. This diminution is the direct consequence of the optimization performed in MATLAB. In ADAMS software, when modeling contacts, the most difficult point is to introduce the appropriate contact parameters. For this purpose, in the ADAMS simulations we have used the contact parameters provided by experimental tests.

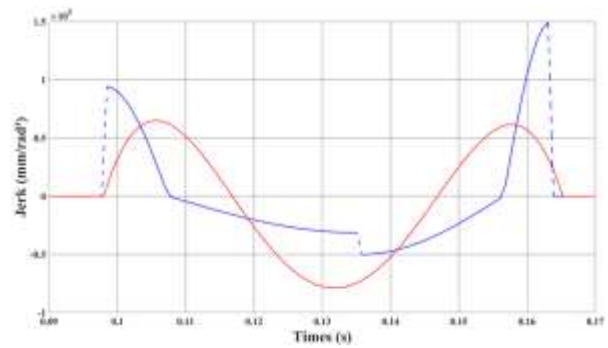

**Fig. 8:** Jerk generated by the previous and optimized motion laws

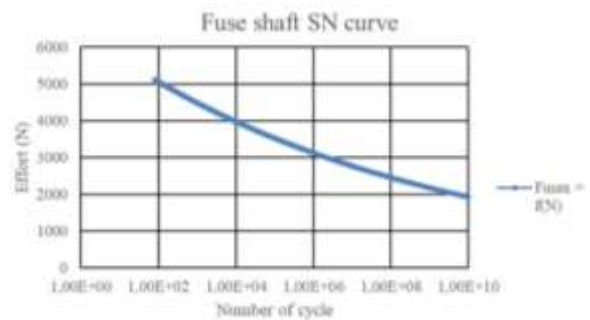

**Fig. 9:** SN Curve of the fuse shaft, maximal effort in the mechanism in regards to the number of cycles

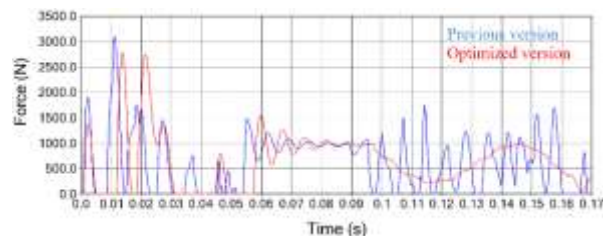

**Fig. 10:** Simulation of the contact force between the cam and the follower through ADAMS software

The ADAMS simulations have shown that the minimization effect is greater compared to the simulation on MATLAB since in this case additional effects are taken into account such as real contacts between links, shocks, and vibrations.

#### Experimental Validation of the Optimized Cam Profile

In order to increase the lifetime of the mechanism, the reduction of contact forces is a key point. Observations of the existing cam have shown that in zones of the cam profile, where the contact forces are maximum, premature wear appears (Fig. 11). With the suggested optimization



technique, it will be shown a reduction of the maximal force value generates the wear.

The cam based on the optimized profile was manufactured and installed on one of the industrial machines. Figure 12 shows the profiles of the previous and optimized cams.

Figures 13 and 14, the examined mechanism with springs and follower, as well as the wires connected to the strain gauge, are shown. All this protocol is established to measure the force in the mechanism. The gauge is directly put on the axle, which is the critical element so the force that transits into this piece is directly the one that gives us the lifetime.

Figure 15 shows the cam mechanism, which has been tested, as well as the fixations and sensors. The setup of this cam is extremely important for a good match between practice and theoretical results. It should be noted that the technician's experience is key.

The obtained results are very encouraging. They are shown in Fig. 16. A 20% reduction in the maximal effort for the maximal speed has been achieved. The correlation of simulations and experimental tests, i.e., between the theoretical estimations and the measures is quite good. The improvement, which is the result of the suggested method, is very satisfying. With rain, flow counts the lifetime of the cam mechanism can be determined. This is based on the Dang Van method, in which the evolution of the lifetime is exponential in regard to the diminution of the maximal effort. It should be noted that the life of the cam mechanism optimized by the proposed method increases from 108 million to 2.09 billion cycles. Thus, the service life of the machine is increased by 19.3 times.



**Fig. 11:** Wear of the cam in the zone where the contact forces are maximum

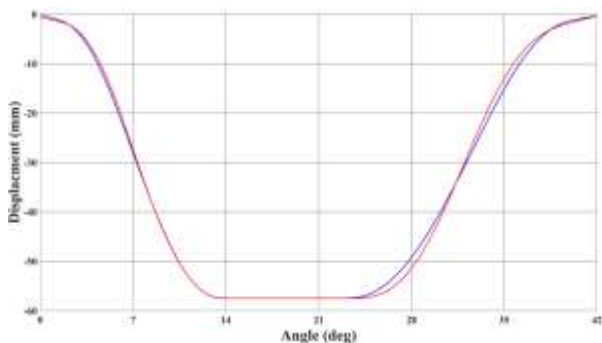

**Fig. 12:** Previous and optimized profiles of the cam



**Fig. 13:** Follower of the mechanism



**Fig. 14:** Instrumentation of the follower's axle for measuring the contact forces between the follower and the cam



**Fig. 15:** Mechanism with new cam

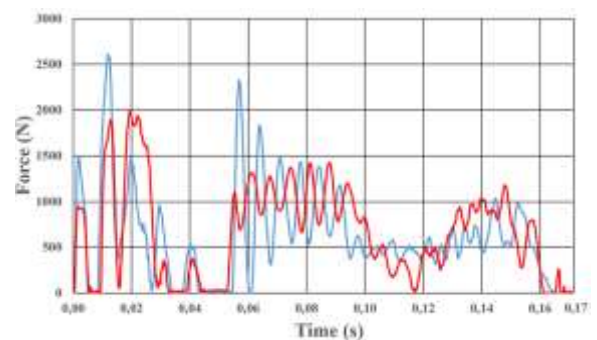

**Fig. 16:** Measured contact force between the follower and the cam

The given optimization is illustrated for the maximal speed but it is also interesting to see the effect of the suggested optimization for other machine speeds.

The given analysis shows that with a lower operating speed of the machine, the effect of the suggested optimization on the contact force and the lifetime is greater.

## Conclusion

Nowadays, given the continuous improvement of industrial machines, it has become quite difficult to develop new methods that can find practical applications. It is often not enough to apply a single software. Therefore, in the paper, it is developed an optimization approach based on the multistage interconnection of different tools: MATLAB, ADAMS, and Mode frontier.

A multi-criteria design optimization of cam mechanisms combining different splines given by fixed and adjustable checkpoints is discussed. Three main stages are considered: The polynomial representation of splines, the fitting of the splines, and the optimization algorithm including the adjustable checkpoints for ensuring the given objectives and constraints. ADAMS determines the dynamic parameters, then the polynomials representing the splines are developed in MATLAB and this is optimized by interacting with mode frontier to get the best profile. Such an approach gives more flexibility and allows the interconnection of the various means of calculation and optimization into a single algorithm.

In order to better explain the suggested approach, an illustrative example with simulations carried out on the base of an industrial cam profile is presented. The existing curve of a production machine is optimized according to seven fixed and adjustable checkpoints and three criteria: The minimization of the maximal value of Hertz pressure, the increase of the contact force in a specific zone to ensure the permanent contact between the cam and the roller follower and the continuity of Jerk for the whole cam profile. To evaluate the efficiency of the suggested solution, the cam was developed and mounted on one of the industrial machines. The experimental test results show a good correlation with the numerical simulations. It was shown that the lifetime of the optimized cam mechanism is multiplied by 19 times. These good results are achieved by reducing the Hertz pressure, which is the main parameter in the cam's lifetime calculation. To minimize this value, there are two aspects to consider: The force generated by the curve and the topology of the curve itself. All minimizations in the theoretical solution are improved by simulations and even on real tests. It is important to note that modeling a cam mechanism without real contacts results in less perceptible minimization than with them.

This is due to shocks and vibrations that are directly related to the motion law. Such effects are difficult to simulate using explicit expressions and were realized using ADAMS software.

The obtained result is particularly noteworthy because the examined cam profile is currently used in an industrial machine and has been optimized several times over the past decade via traditional optimization methods. This proves that the proposed approach is a really effective way to optimize cam profiles.

Finally, it should be noted that the procedure of optimization is automatic, quite fast, and reliable, which can be widely used in various engineering projects.

## Acknowledgment

Thank you to the publisher for their support in the publication of this research article. We are grateful for the resources and platform provided by the publisher, which have enabled us to share our findings with a wider audience. We appreciate the efforts of the editorial team in reviewing and editing our work, and we are thankful for the opportunity to contribute to the field of research through this publication.

## Funding Information

The author's have not received any financial support or funding to report.

## Author's Contributions

**Léo Moussafir:** Methodology and CAD simulations, participation in tested.

**Vigen Arakelian:** Conceptualization and edited of the manuscript.

## Ethics

This study is original and it is not under consideration for publication elsewhere. The authors declare that are no ethical issues and no conflict of interest that may arise after the publication of this manuscript.

## References

- Acharyya, S., & Naskar, T. K. (2008). Fractional polynomial mod traps for optimization of jerk and hertzian contact stress in cam surface. *Computers & Structures*, 86(3-5), 322-329.  
<https://doi.org/10.1016/j.compstruc.2007.01.045>
- Andresen, U., & Singhose, W. (2004). A simple procedure for modifying high-speed cam profiles for vibration reduction. *J. Mech. Des.*, 126(6), 1105-1108.  
<https://doi.org/10.1115/1.1798231>

- Bobzin, K., Bagcivan, N., Ewering, M., & Brugnara, R. H. (2012). Vanadium alloyed PVD CrAlN coatings for friction reduction in metal forming applications. *Tribology in Industry*, 34(2), 101. <http://www.tribology.rs/journals/2012/2012-2/7.pdf>
- Borboni, A., Aggogeri, F., Elamvazuthi, I., Incerti, G., & Magnani, P. L. (2020). Effects of profile interpolation in cam mechanisms. *Mechanism and Machine Theory*, 144, 103652. <https://doi.org/10.1016/j.mechmachtheory.2019.103652>
- Bouzakis, K. D., Mitsi, S., & Tsiafis, J. (1997). Computer-aided optimum design and NC milling of planar cam mechanisms. *International Journal of Machine Tools and Manufacture*, 37(8), 1131-1142. [https://doi.org/10.1016/S0890-6955\(96\)00040-5](https://doi.org/10.1016/S0890-6955(96)00040-5)
- Bouzakis, K. D., Skordaris, G., Michailidis, N., Mirisidis, I., Erkens, G., & Cremer, R. (2007). Effect of film ion bombardment during the pvd process on the mechanical properties and cutting performance of TiAlN coated tools. *Surface and Coatings Technology*, 202(4-7), 826-830. <https://doi.org/10.1016/j.surfcoat.2007.06.025>
- Cabrera, J. A., Simon, A., & Prado, M. (2002). Optimal synthesis of mechanisms with genetic algorithms. *Mechanism and Machine Theory*, 37(10), 1165-1177. [https://doi.org/10.1016/S0094-114X\(02\)00051-4](https://doi.org/10.1016/S0094-114X(02)00051-4)
- Cardona, A., Lens, E., & Nigro, N. O. R. B. E. R. T. O. (2002). Optimal design of cams. *Multibody System Dynamics*, 7, 285-305. <https://doi.org/10.1023/A:1015278213069>
- Cardona, S., Zayas, E. E., Jordi, L., & Català, P. (2013). Synthesis of displacement functions by Bézier curves in constant-breadth cams with parallel flat-faced double translating and oscillating followers. *Mechanism and Machine Theory*, 62, 51-62. <https://doi.org/10.1016/j.mechmachtheory.2012.11.004>
- Chen, F. Y. (1982). *Mechanics and design of cam mechanisms*. Pergamon.
- Dennis Jr, J. E., & Woods, D. J. (1985). *Optimization on microcomputers. The Nelder-Mead Simplex Algorithm*. <https://doi.org/10.21236/ADA453814>
- Flocker, F. W. (2007). Controlling the frequency content of inertia forces in dwelling cam-follower systems. <https://doi.org/10.1115/1.2712222>
- Flocker, F. W. (2009). Addressing cam wear and follower jump in single-dwell cam-follower systems with an adjustable modified trapezoidal acceleration cam profile. *Journal of Engineering for Gas Turbines and Power*, 131(3). <https://doi.org/10.1115/1.3030874>
- Flocker, F. W., & Bravo, R. H. (2013). A closed-Form solution for minimizing the cycle time in motion programs with constant velocity segments. *Journal of Mechanical Design*, 135(1). <https://doi.org/10.1115/1.4007930>
- Guo, J., Cao, Y., Zhang, W., & Zhang, X. (2015). A new numerical method for developing the lumped dynamic model of valve train. *Journal of Engineering for Gas Turbines and Power*, 137(10). <https://doi.org/10.1115/1.4030093>
- Hu, B., Zhou, C., Wang, H., & Yin, L. (2021). Prediction and validation of dynamic characteristics of a valve train system with flexible components and gyroscopic effect. *Mechanism and Machine Theory*, 157, 104222. <https://doi.org/10.1016/j.mechmachtheory.2020.104222>
- Hwang, W. M., & Yu, C. Z. (2005). Optimal synthesis of the adjustable knock-out cam-follower mechanism of a bolt former. *Proceedings of the Institution of Mechanical Engineers, Part C: Journal of Mechanical Engineering Science*, 219(8), 767-774. <https://doi.org/10.1243/095440605X31553>
- Jabbado, M. (2006). *Fatigue polycyclique des structures métalliques: Durée de vie sous chargements variables* (Doctoral dissertation, Ecole Polytechnique X). <https://pastel.archives-ouvertes.fr/pastel-00002116/>
- JCMA. (2001). Cam mechanism handbook. *The Nikkan Kogyo Shinbun Ltd., Tokyo*, 311-323.
- Kaplan, H. (2014). Mathematical modeling and simulation of high-speed cam mechanisms to minimize residual vibrations. *Proceedings of the Institution of Mechanical Engineers, Part C: Journal of Mechanical Engineering Science*, 228(13), 2402-2415. <https://doi.org/10.1177/0954406213519436>
- Mandal, M., & Naskar, T. K. (2009). Introduction of control points in splines for synthesis of optimized cam motion program. *Mechanism and Machine Theory*, 44(1), 255-271. <https://doi.org/10.1016/j.mechmachtheory.2008.01.005>
- Mansour, G., Sagris, D., Tsiafis, C., Mitsi, S., & Bouzakis, K. D. (2013). Evolution of Hybrid Method for Industrial Manipulator Design Optimization. *Journal of Production Engineering*, 16(1), 35-38.
- Mermelstein, S. P., & Acar, M. (2004). Optimising cam motion using piecewise polynomials. *Engineering with Computers*, 19, 241-254. <https://doi.org/10.1007/s00366-003-0264-0>
- Mitsi, S., Bouzakis, K. D., Tsiafis, I., & Mansour, G. (2001). Optimal synthesis of cam mechanisms using cubic spline interpolation for cam NC milling. *Journal Balkan Tribological Association*, 7(3/4), 225-233.
- Naskar, T. K., & Mishra, R. (2012). Introduction of control points in B-splines for synthesis of ping finite optimized cam motion program. *Journal of Mechanical Science and Technology*, 26(2), 489. <https://doi.org/10.1007/s12206-011-1004-9>

- Nga, N. T. T., Van-Sy, N., Ngoc, N. T. B., & Lien, V. T. (2021). An evaluation of B-spline for synthesis of Cam motion with a large number of output conditions. In *Advances in Engineering Research and Application: Proceedings of the International Conference on Engineering Research and Applications, ICERA 2020* (pp. 173-180). Springer International Publishing.  
[https://doi.org/10.1007/978-3-030-64719-3\\_20](https://doi.org/10.1007/978-3-030-64719-3_20)
- Nguyen, T. N., Kurtenbach, S., Hüsing, M., & Corves, B. (2019). A general framework for motion design of the follower in cam mechanisms by using non-uniform rational B-spline. *Mechanism and Machine Theory*, 137, 374-385.  
<https://doi.org/10.1016/j.mechmachtheory.2019.03.029>
- Norton, R. L. (2002). *Cam design and manufacturing handbook*. Industrial Press Inc.  
ISBN-10: 9780831131227.
- Ottaviano, E., Mundo, D., Danieli, G. A., & Ceccarelli, M. (2008). Numerical and experimental analysis of non-circular gears and cam-follower systems as function generators. *Mechanism and Machine Theory*, 43(8), 996-1008.  
<https://doi.org/10.1016/j.mechmachtheory.2007.07.004>
- Ouyang, T., Wang, P., Huang, H., Zhang, N., & Chen, N. (2017). Mathematical modeling and optimization of cam mechanism in delivery system of an offset press. *Mechanism and Machine Theory*, 110, 100-114.  
<https://doi.org/10.1016/j.mechmachtheory.2017.01.004>
- Qin, W. J., & He, J. Q. (2010). Optimum design of local cam profile of a valve train. *Proceedings of the Institution of Mechanical Engineers, Part C: Journal of Mechanical Engineering Science*, 224(11), 2487-2492.  
<https://doi.org/10.1243/09544062JMES2116>
- Qiu, H., Lin, C. J., Li, Z. Y., Ozaki, H., Wang, J., & Yue, Y. (2005). A universal optimal approach to cam curve design and its applications. *Mechanism and Machine Theory*, 40(6), 669-692.  
<https://doi.org/10.1016/j.mechmachtheory.2004.12.005>
- Reeve, J. (1995). *Cams for industry: A handbook for designers of special-purpose machines*. Mechanical Engineering.
- Sateesh, N., Rao, C. S. P., & Janardhan Reddy, T. A. (2009). Optimisation of cam-follower motion using B-splines. *International Journal of Computer Integrated Manufacturing*, 22(6), 515-523.  
<https://doi.org/10.1080/09511920802546814>
- Ting, K. L., Lee, N. L., & Brandan, G. H. (1994). Synthesis of polynomial and other curves with the Bezier technique. *Mechanism and Machine Theory*, 29(6), 887-903. [https://doi.org/10.1016/0094-114X\(94\)90088-4](https://doi.org/10.1016/0094-114X(94)90088-4)
- Tsay, D. M., & Lin, B. J. (1996). Improving the geometry design of cylindrical cams using nonparametric rational B-splines. *Computer-Aided Design*, 28(1), 5-15.  
[https://doi.org/10.1016/0010-4485\(95\)00020-8](https://doi.org/10.1016/0010-4485(95)00020-8)
- Tsiafis, I., Paraskevopoulou, R., & Bouzakis, K. D. (2009). Selection of optimal design parameters for a cam mechanism using multi-objective genetic algorithm. *Annals of the "Constantin Brancusi" University of Targu Jiu, Engineering Series*, (2), 57-66.
- Wu, L. I., Liu, C. H., & Chen, T. W. (2009). Disc cam mechanisms with concave faced followers. *Proceedings of the Institution of Mechanical Engineers, Part C: Journal of Mechanical Engineering Science*, 223(6), 1443-1448.  
<https://doi.org/10.1243/09544062JMES1320>
- Xiao, H., & Zu, J. W. (2009). Cam profile optimization for a new cam drive. *Journal of Mechanical Science and Technology*, 23, 2592-2602.  
<https://doi.org/10.1007/s12206-009-0715-7>
- Yan, H. S., Tsai, M. C., & Hsu, M. H. (1996a). A variable-speed method for improving motion characteristics of cam-follower systems.  
<https://doi.org/10.1115/1.2826877>
- Yan, H. S., Tsai, M. C., & Hsu, M. H. (1996b). An experimental study of the effects of cam speeds on cam-follower systems. *Mechanism and Machine Theory*, 31(4), 397-412.  
[https://doi.org/10.1016/0094-114X\(95\)00087-F](https://doi.org/10.1016/0094-114X(95)00087-F)